

OCULUS Corvis® ST
Corneal Visualization
Scheimpflug Technology

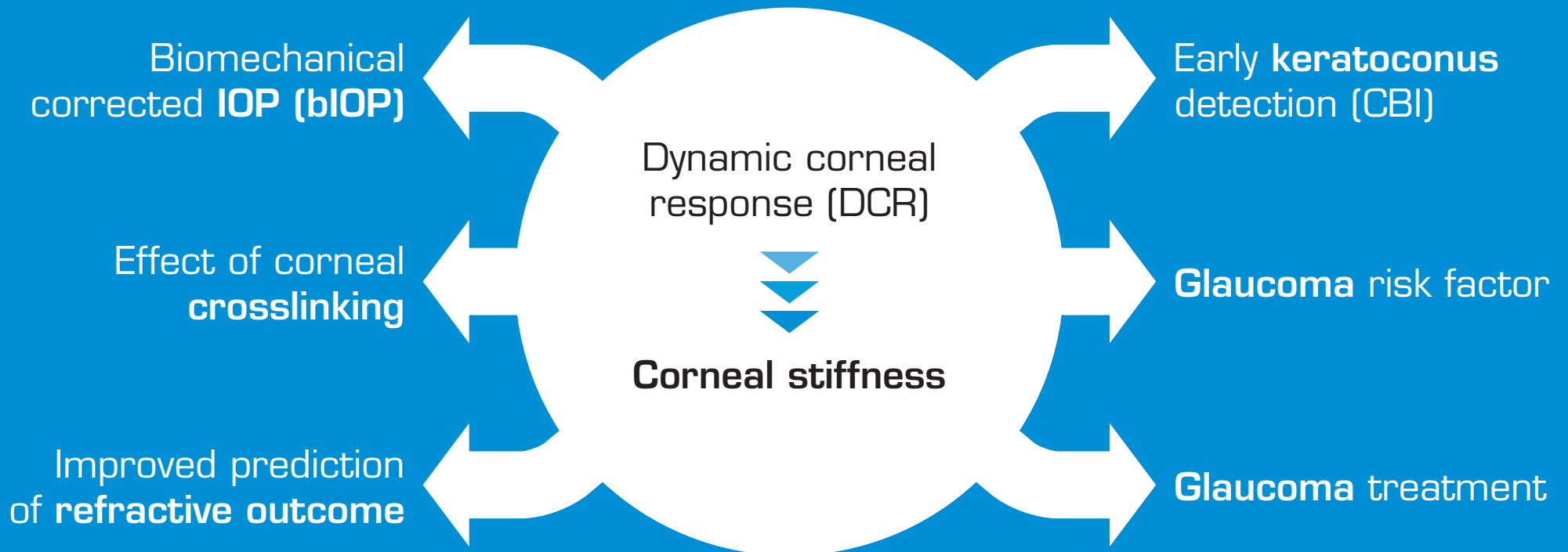

Why are biomechanical properties so important?



OCULUS Corvis® ST

Evaluation of corneal biomechanical response, tonometry and pachymetry

The revolutionary Corvis® ST records the reaction of the cornea to a defined air pulse using a newly developed high-speed Scheimpflug camera. This camera captures over 4,300 images per second, permitting highly precise measurement of IOP and corneal thickness. Based on a video of 140 images, taken within 31 ms after onset of the air pulse, the Corvis® ST provides a detailed assessment of corneal biomechanical properties.

The information obtained on the biomechanical response of the cornea is used to calculate a biomechanically corrected IOP (bIOP). Furthermore it allows ectatic diseases such as keratoconus to be detected at a very early stage. Biomechanical properties also play an important role in the development and progression of glaucoma.

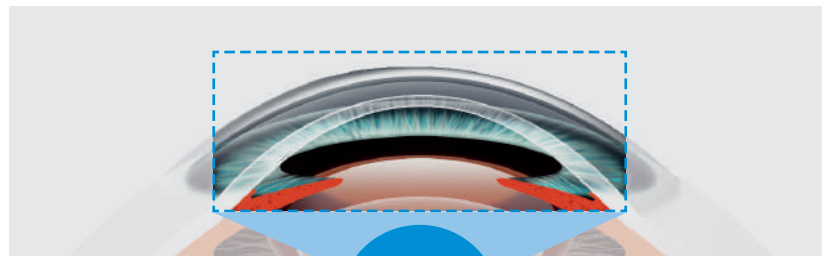

A high-speed Scheimpflug camera takes more than 4,300 images per second

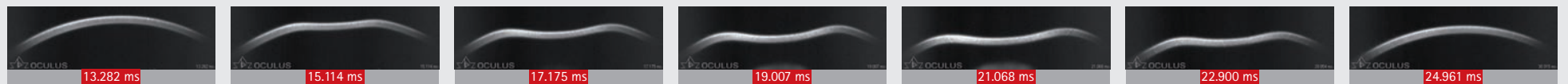

IOP/Pachy Display

Biomechanical corrected IOP (bIOP)

More accurate IOP readings, less dependent on biomechanical properties and corneal thickness. The data are easy to read and to interpret, also the IOP follow-up is neatly arranged.

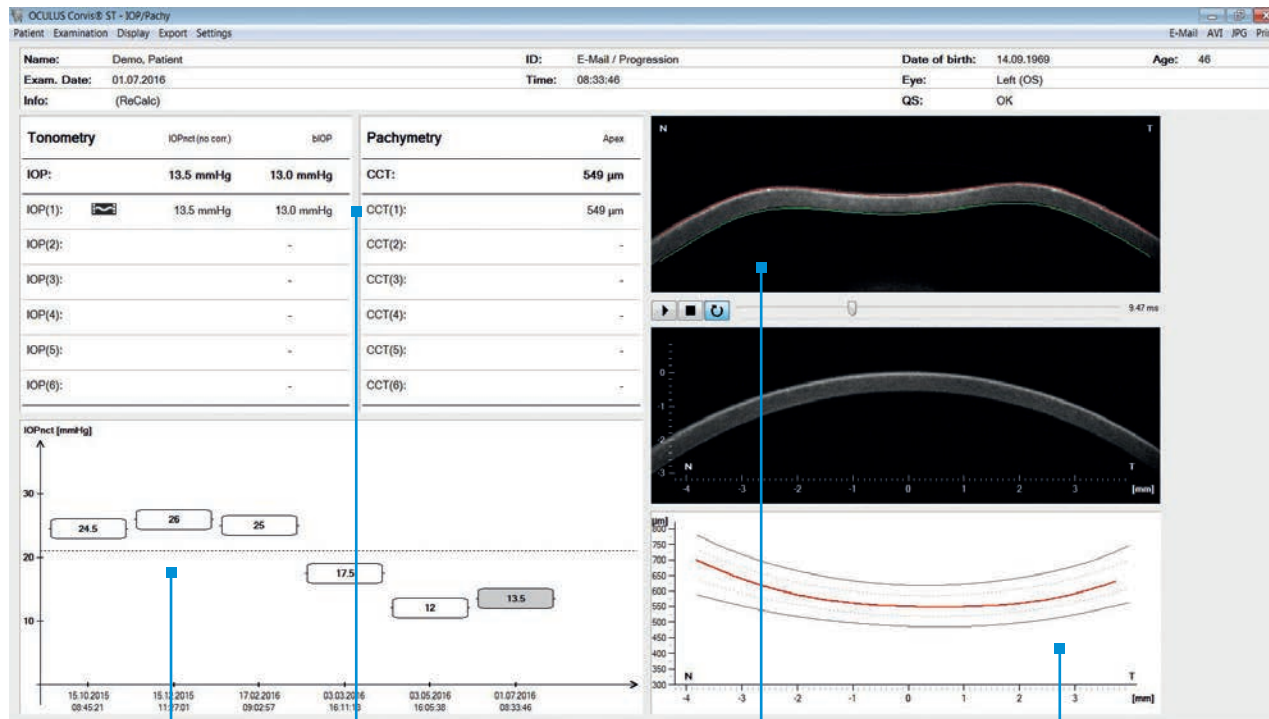

IOP correction is based on corneal thickness, age and the biomechanical response of the cornea. When calculated this way IOP is less influenced by corneal properties and thickness than it is with other measurement methods. As the Corvis® ST measures both biomechanical response and corneal thickness with high precision, the device is able to correct for both factors at the same time.

Due to the measurement principle, the IOP measurements are not influenced by tear film. This, and the fast auto tracking and auto release, ensure highly repeatable IOP and thickness readings, completely user-independent.

IOP follow-up

bIOP/CCT measurements

Biomechanical response video

Pachymetric progression

Vinciguerra Screening Report

Corvis Biomechanical Index (CBI)

Comprehensive biomechanical screening and keratoconus detection. The software displays the patient's results in comparison with normative values, presented in easy-to-grasp charts.

This software permits fast and comprehensive screening for corneas with abnormal corneal biomechanical properties. It is the first available screening software that combines biomechanical information with pachymetric progression data. It calculates the Corvis Biomechanical Index (CBI), which enables the detection of ectatic corneas based on these findings. As keratoconus is caused by biomechanical changes and leads to progressive thinning, the software is able to detect the earliest signs of this disease.

Furthermore, the normal ranges of dynamic corneal response (DCR) parameters are shown as a function of IOP. Standardized parameters indicate whether the cornea has a normal biomechanical response.

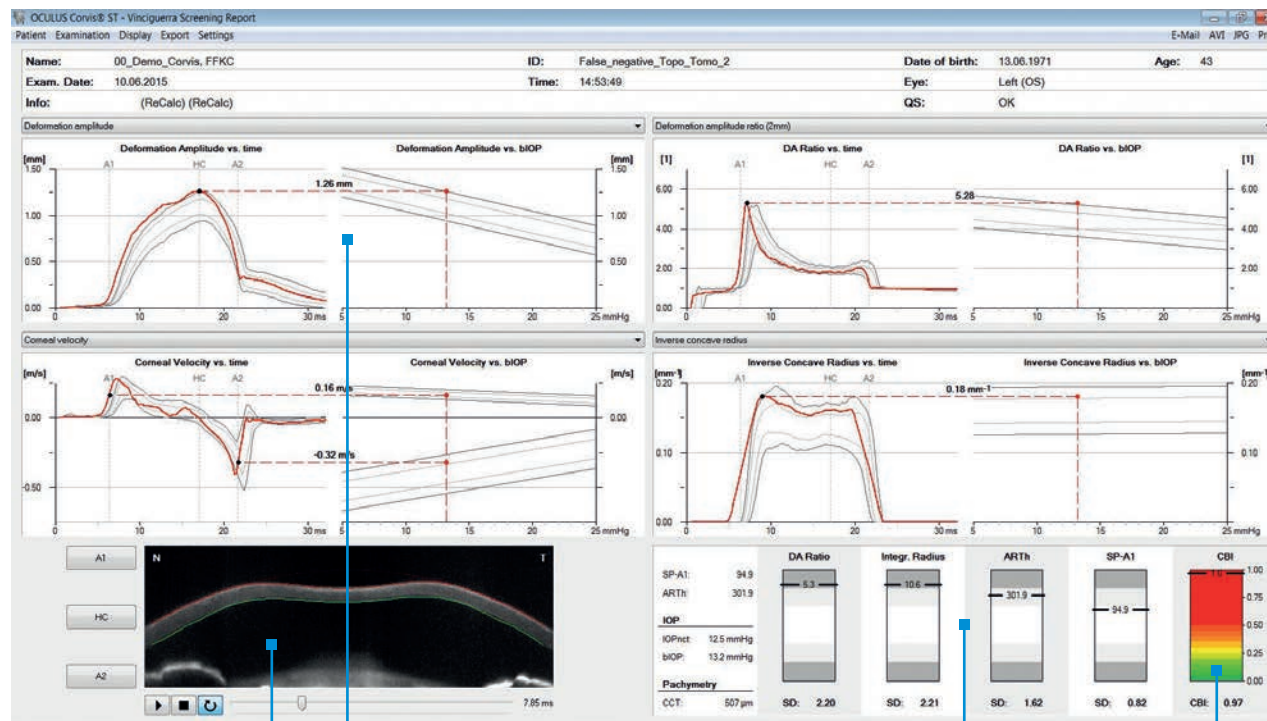

Biomechanical response video

Normal ranges for dynamic corneal response (DCR) parameters

Standard deviation for screening parameters

Corvis Biomechanical Index (CBI)

Tomographic and Biomechanical Assessment

Tomographic Biomechanical Index (TBI)

Integration of Pentacam® data for a combined tomographic and biomechanical analysis. The best of two worlds: TBI is calculated using an artificial intelligence approach to optimize ectasia detection.

By combining tomographic data from the Pentacam® with biomechanical data from the Corvis® ST one can further improve sensitivity and specificity in the detection of patients with a significant risk for developing ectasia after refractive surgery. The outcome of this analysis is supplied by the Tomographic Biomechanical Index (TBI). This index together with the comprehensive display helps you to avoid risks and to treat more patients safely.

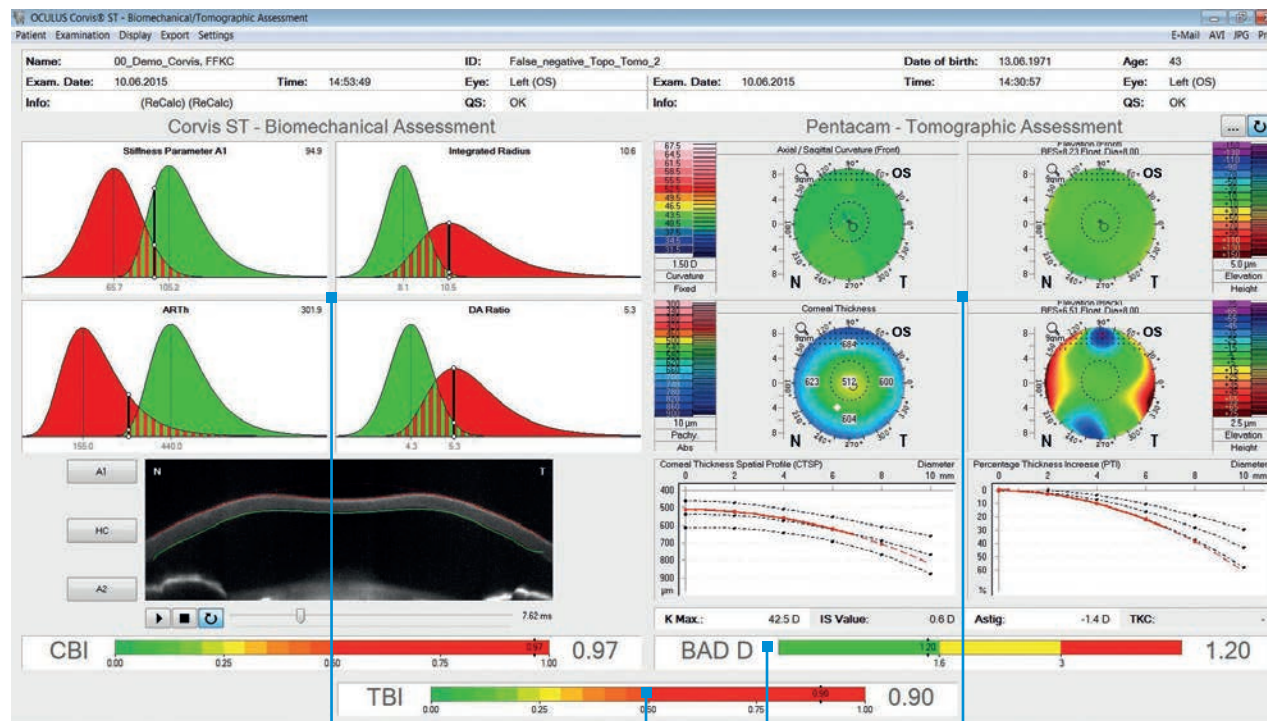

Screening values in comparison to populations of healthy (green) and keratoconic (red) patients

Tomographic Biomechanical Index (TBI)

Belin / Ambrósio D value (Pentacam®)

4 Maps Refractive (Pentacam®)

Combining Tomography with Biomechanical Properties gives you the complete view



Pentacam®
measurement data →



Pentacam®
data →

←
Tomographic
Biomechanical
Assessment



↓
Clinic
network



Viewing stations

Included software
IOP/Pachy Display <i>with bIOP</i>
IOP Progression
Available software
Dynamic Corneal Response Display
Vinciguerra Screening Report <i>with CBI</i>
Tomographic* Biomechanical Assessment <i>with TBI</i>

* Pentacam® essential

Technical Data

OCULUS Corvis® ST

Tonometer	
Measurement range	6 - 60 mmHg
Measurement distance	11 mm (0.4 in)
Inner fixation light	Red LED
3D auto tracking & auto release	
Scheimpflug camera	
Frame rate	4,330 images per sec
Measurement range	8.5 mm (0.3 in) horizontal coverage
Pachymeter measurement range	300 - 1,200 µm
Measuring points	576 per image (80,640 per examination)
Source of light	Blue LED (470 nm UV free)
Technical specifications	
Dimensions (W x D x H)	266 x 538 x 495 - 525 mm (10.5 x 21.2 x 19.5 - 20.7 in)
Weight	14 kg (30.8 lbs)
Max. power consumption	26 W
Voltage	100 - 240 V
Frequency	50 - 60 Hz
Recommended computer specifications	Core i5-4200M, 2.5 GHz, 4 GB, 500 GB, Windows® 7, Intel HD graphics 4600

CE in accordance with Medical Device Directive 93/42/EEC

WWW.OCULUS.DE



OCULUS is certified by TÜV according to
DIN EN ISO 13485

OCULUS Optikgeräte GmbH

Postfach • 35549 Wetzlar • GERMANY
Tel. +49-641-2005-0 • Fax +49-641-2005-295
Email: export@oculus.de • www.oculus.de

- OCULUS Asia, info@oculus.hk
- OCULUS Czechia, oculus@oculus.cz
- OCULUS Iberia, info@oculus.es
- OCULUS Poland, biuro@oculus.pl
- OCULUS Turkey, info@oculus-turkey.com.tr

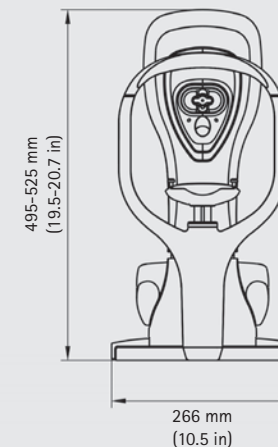
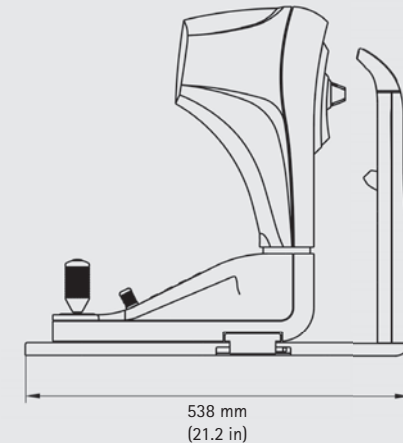

The availability of products and features may vary by country. OCULUS reserves the right to change product specifications and design. All information is valid at the time of printing (03/17)



27/0317/EN/HA
P/72100/EN